



KALORINA K 25 E



**CALDAIE A BIOMASSA
SISTEMI SOLARI**
Zona ind.le - Scalo ferroviario
52022 Cammarata (Ag)
Tel. +39 0922 901375
E-mail: tatano@tatano.it
www.tatano.it

BOILER MODEL			K 25 04 E
Generator type			Smoke tubes
Carrier Fluid			Air
Rated Power		<i>kW</i>	51
Nominal Power		<i>kW</i>	46
Reduced Power		<i>kW</i>	14
Efficiency	<i>min</i>	%	88
	<i>max</i>	%	92

CONSTRUCTION DATA ⁽¹⁾

Dimensions with standard hopper	<i>Width</i>	<i>mm</i>	(A)	1848	
	<i>Depth</i>	<i>mm</i>	(B)	1342	
	<i>Height with blower</i>	<i>mm</i>	(C)	1806	
	<i>Height with blower</i>	<i>mm</i>	C1	1454	
Dimensions for the opening of the door for cleaning			<i>mm</i>	(L)	469
Loading Door dimensions	<i>Width</i>	<i>mm</i>	(H)	370	
	<i>Height</i>	<i>mm</i>	(I)	220	
Standard hopper volume		<i>litres</i>		380	
Internal dimensions for the adjustable nozzles flanges	<i>Width</i>	<i>mm</i>	(O)	401	
	<i>Depth</i>	<i>mm</i>	(P)	280	
Weight		<i>Kg</i>		606	
Chimney diameter		\emptyset <i>mm</i>	(R)	200	

FAN FEATURES

Motor nominal power		<i>W</i>		590
Nominal frequency		<i>Hz</i>		50
Max absorbed power		<i>A</i>		6,8
Engine rounds		<i>RPM</i>		910
Air flow with free outlet		m^3/h		4800
Sound pressure		<i>db</i>		79

OPERATING DATA

Max working temperature		$^{\circ}C$		85
Air flow		m^3/h		3360
Working pressure		<i>Pa</i>		100
Draught Pressure		<i>Pa</i>		20±(30%)
Smoke temperature		$^{\circ}C$		180±(20%)
Fuel flow setting				Electronic modulating
Ventilation flow setting				Electronic modulating

FUELS

Recommended class			WOOD PELLETT (EN 14961-4)
Fuel with W < 15%			Wood Pellet (EN 14961-2), Sawdust (EN 14961-3), Olive husks, Minced shells and Cereals waste (EN 14961-6), Wood (EN 14961-5)
	<i>Wood max</i>		430 mm

REFERENCE FUEL

CHIPS⁽²⁾

Consumption with nominal power		<i>kg/h</i>	13,4
Consumption with reduced power		<i>kg/h</i>	4,0
Smoke flow with nominal power		<i>Nm³/h</i>	111,0
Smoke flow with reduced power		<i>Nm³/h</i>	33,0

ELECTRICAL DATA⁽³⁾

Control panel			Modulating digital electronic thermoregulator complete with main switch, manual reset thermostat, light indicators
Ignition			Electronical through resistor 250 W, 230 V, 1A
Max absorbed electrical power		<i>W</i>	1750
Average power input		<i>W</i>	750
Rated Voltage		<i>V</i>	230
Nominal frequency		<i>Hz</i>	50
Nominal current		<i>A</i>	13,6

ARRANGEMENTS

Antifire valve application			Through threaded sleeves DN 20
Room thermostat			Output connection

OPTIONAL

Remote Control\Remote Assistance			Wifi module
----------------------------------	--	--	-------------

OBLIGATORY FOR THE INSTALLATION

			Detection valve for gaseous flows
			Fire dampers and expulsion damper
			External room air intake

SECURITY SYSTEM

Signaling, control and boiler stop

Through boiler probe and smoke probe

Manual resetting thermostat

Boiler block for open hatch

Fuel level sensor

Antifire system

Reporting of operating errors

Through visual and/or acoustic alarms

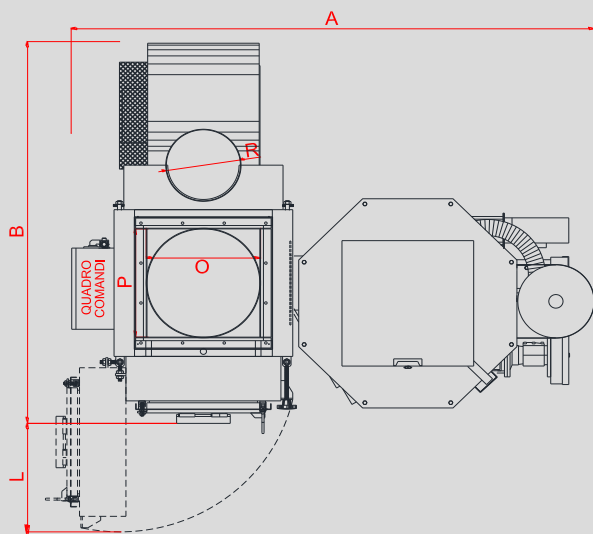
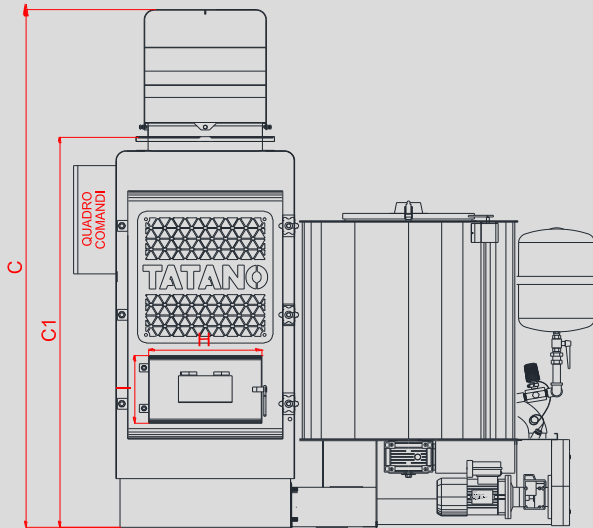

(1) The dimensions may vary depending on the position of the hopper(right-left-rear) or in addition of optional accessories or for constructive choices.

(2) The data concerning consumption may vary according to the characteristics of the fuel used, or for the operating conditions.

(3) Data may vary according to the electrical components installed (motors, fans, etc.). The actual data will be shown on the plate attached to the boiler.

The company reserves the right to change dimensions and features without prior notice, declines all responsibility for errors in transcription or printing.